

SRH TB FR 1500 X 750MM
THERMALLY BROKEN INSULATION U-VALUE 0.63W/M2K
UP TO 4 HOUR FIRE RESISTANCE FOR INTEGRITY TO EN1634-1:2014

1 No. REQD
MATERIAL: ALUMINIUM & GALVANISED STEEL
FINISH: SELF COLOUR

APPROX WEIGHT: 225KG

ALL EXTERNAL FIXINGS
BY OTHERS

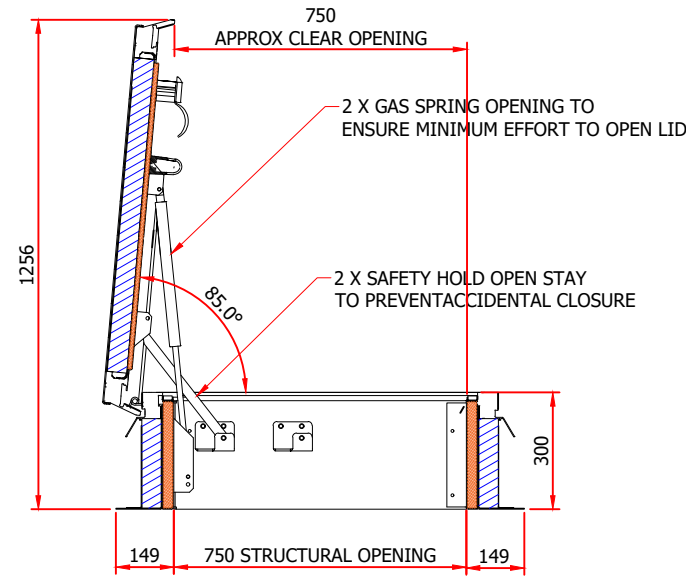
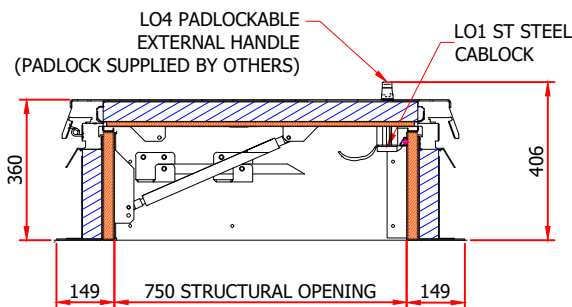
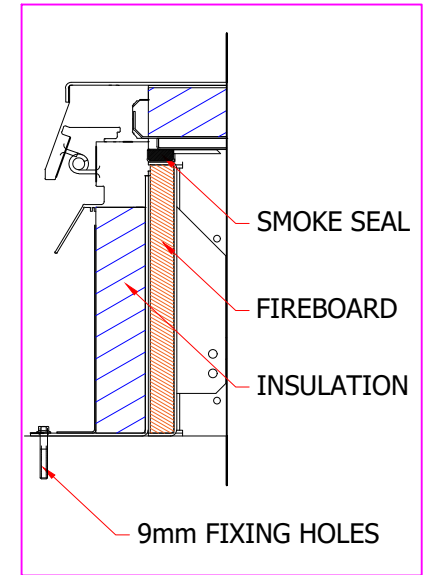

LASER CUT	
PUNCH PRESS	
FOLDING	
DRILLING	
WELDING	
ASSEMBLY	
POWDER COAT	

DRAWING MADE BY CAD
MANUAL CHANGES PROHIBITED

Copyright is claimed in this drawing and no copy may be made without prior written permission.

The article shown is also the subject of:
patent rights
registered design rights
unregistered rights
this drawing is a design document
patent pending

WIND RESTRAINTS SHOULD BE SPECIFIED ON ALL ACCESS HATCHES SUBJECT TO HIGH WIND CONDITIONS
THIS IS A MANUALLY OPERATED ACCESS HATCH/COVER & IT IS ESSENTIAL THAT SAFE MEANS OF ACCESS IS PROVIDED FOR THE OPERATOR



Designed by SURESPAN
Checked by SURESPAN
Client ...

EXISTING LAW PROTECTS SURESPAN'S RIGHT OF POSSESSION TO THIS DRAWING. THE DESIGN OR THE DRAWING MUST NOT, WITHOUT PERMISSION OF THE COMPANY, BE PUBLISHED, COPIED, REPRODUCED MANUFACTURED OR EXPLOITED IN ANY OTHER UNAUTHORIZED WAY

Project ...
Date 01.08.2020

Surespan SRH/TB/FR 1500 X 750MM

Revision
Sheet 1 / 30