

SRH TB FR 600 X 600MM
 THERMALLY BROKEN INSULATION U-VALUE 0.63W/M2K
 UP TO 4 HOUR FIRE RESISTANCE FOR INTEGRITY TO EN1634-1:2014

1 No. REQD
 MATERIAL: ALUMINIUM & GALVANISED STEEL
 FINISH: SELF COLOUR

APPROX WEIGHT: 120KG

ALL EXTERNAL FIXINGS
 BY OTHERS

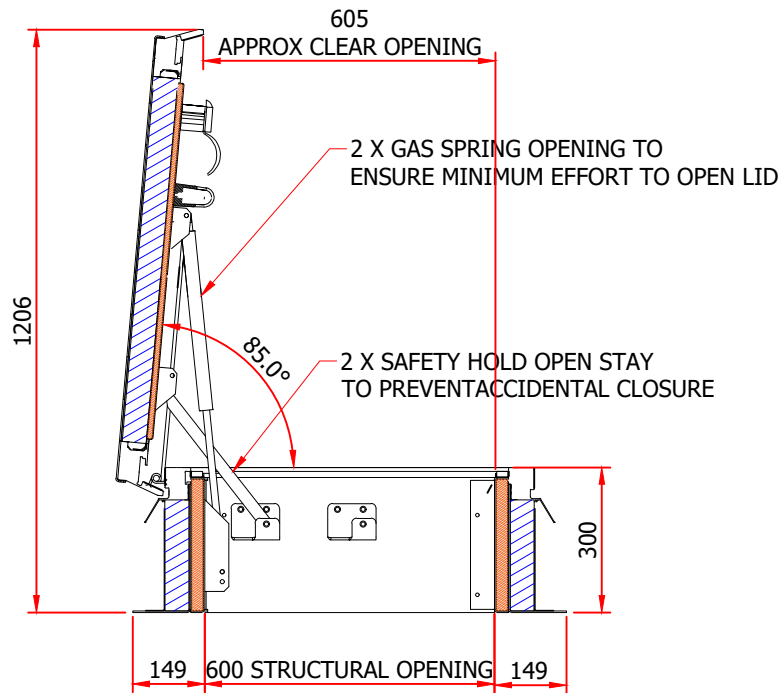
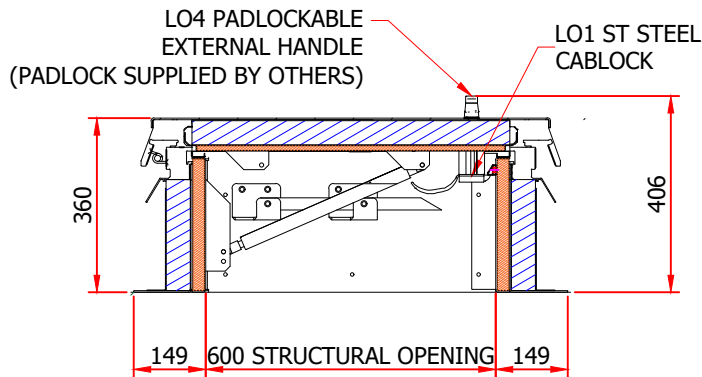
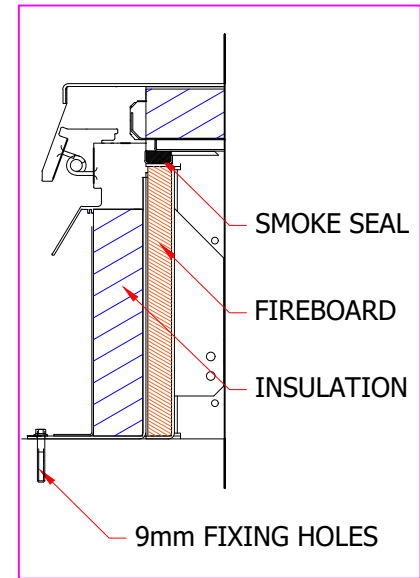

LASER CUT	
PUNCH PRESS	
FOLDING	
DRILLING	
WELDING	
ASSEMBLY	
POWDER COAT	

DRAWING MADE BY CAD
 MANUAL CHANGES PROHIBITED

Copyright is claimed in this drawing and no copy may be made without prior written permission.

The article shown is also the subject of:
 patent rights
 registered design rights
 unregistered rights
 this drawing is a design document
 patent pending

WIND RESTRAINTS SHOULD BE SPECIFIED ON ALL ACCESS HATCHES SUBJECT TO HIGH WIND CONDITIONS
 THIS IS A MANUALLY OPERATED ACCESS HATCH/COVER & IT IS ESSENTIAL THAT SAFE MEANS OF ACCESS IS PROVIDED FOR THE OPERATOR



Designed by SURESPAN
 Checked by SURESPAN
 Client ...

EXISTING LAW PROTECTS SURESPAN'S RIGHT OF POSSESSION TO THIS DRAWING. THE DESIGN OR THE DRAWING MUST NOT, WITHOUT PERMISSION OF THE COMPANY, BE PUBLISHED, COPIED, REPRODUCED MANUFACTURED OR EXPLOITED IN ANY OTHER UNAUTHORIZED WAY

Project ...	Date 01.08.2020
Surespan SRH/TB/FR 600 X 600MM	
Revision	Sheet 1 / 30