

CONFIDENTIAL

DIMENSIONS IN mm UNLESS OTHERWISE SPECIFIED - IF IN DOUBT ASK

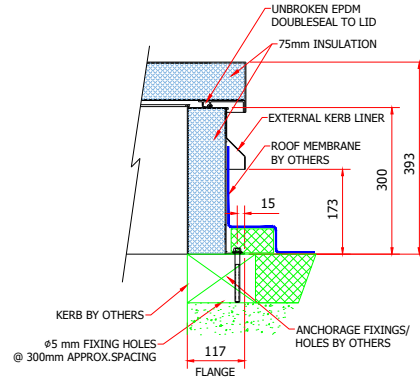
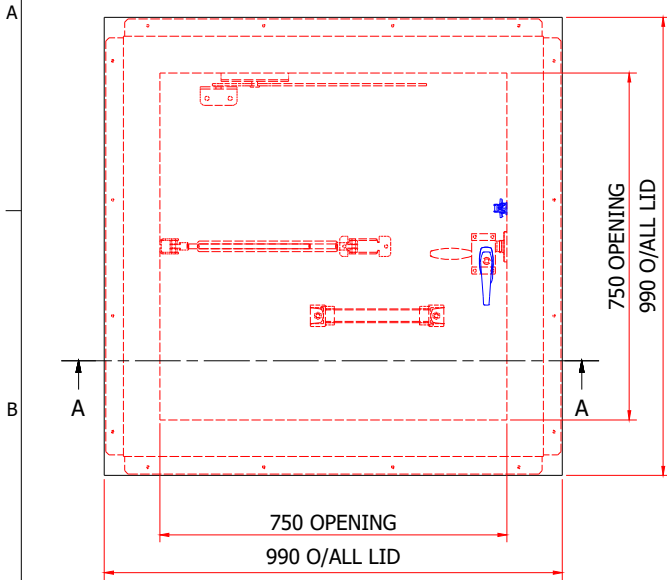

SRHP75
 SIZE: 750 X 750 mm
 UPSTAND HEIGHT: 300 mm
 LOCKING OPTION: LO1 (INTERNAL CABLOCK)
 LO2 (PADLOCKABLE TOGGLE LATCH) & LO4 (PADLOCKABLE EXT HANDLE)
 INCLUDED AS STANDARD IF REQUIRED
 MATERIAL: ALUMINIUM
 INSULATION: 75mm INSULATION

INTERNAL COLOUR: MILL FINISH
 EXTERNAL COLOUR: MILL FINISH

APPROX WEIGHT: 44 kg

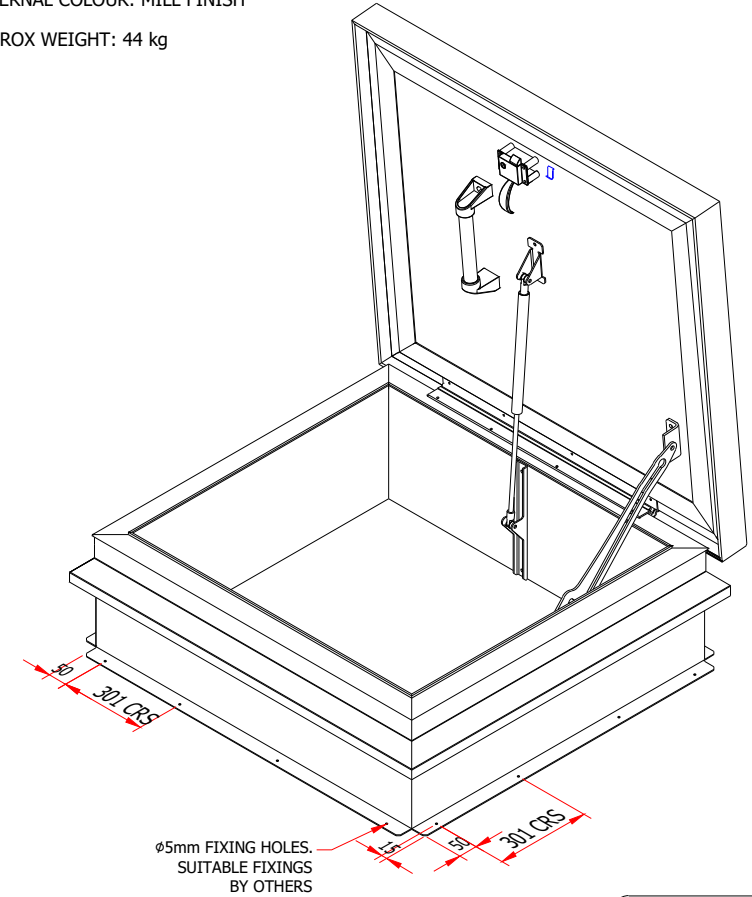
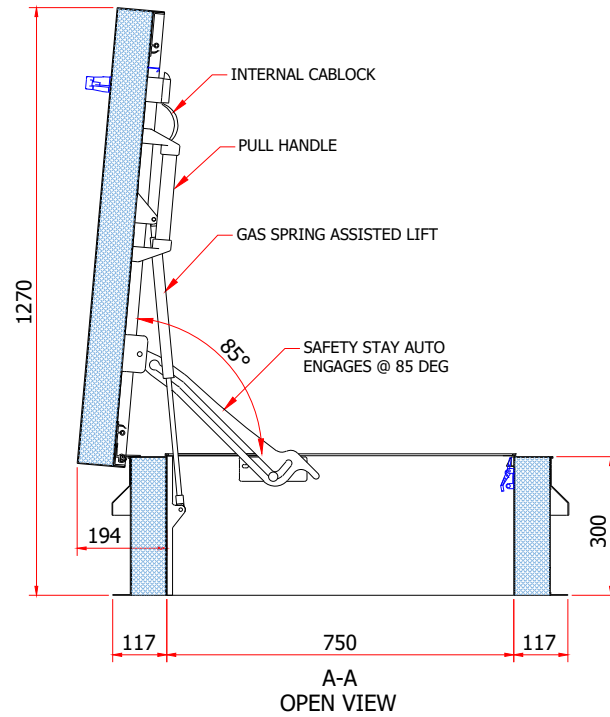
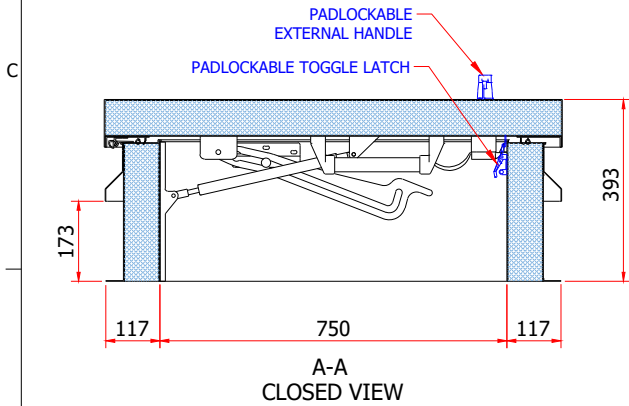

DRAWING MADE BY CAD
 MANUAL CHANGES PROHIBITED

Copyright is claimed in this drawing and no copy may be made without prior written permission.

The article shown is also the subject of:
 patent rights
 registered design rights
 unregistered rights
 this drawing is a design document
 patent pending

WIND RESTRAINTS SHOULD BE SPECIFIED ON ALL ACCESS HATCHES SUBJECT TO HIGH WIND CONDITIONS
 THIS IS A MANUALLY OPERATED ACCESS HATCH/COVER & IT IS ESSENTIAL THAT SAFE MEANS OF ACCESS IS PROVIDED FOR THE OPERATOR



Designed by SURESPAN	Checked by SURESPAN	Client	Project	Date 01.09.2020
EXISTING LAW PROTECTS SURESPAN'S RIGHT OF POSSESSION TO THIS DRAWING. THE DESIGN OR THE DRAWING MUST NOT, WITHOUT PERMISSION OF THE COMPANY, BE PUBLISHED, COPIED, REPRODUCED MANUFACTURED OR EXPLOITED IN ANY OTHER UNAUTHORIZED WAY			SRHP75_750 x 750 mm	
STOCK SRHP75_750 x 750 mm			Revision	Sheet 1